



No.1 in Form & Funktion

Catalogue



STRIPPING TOOLS



NEW

0.2-16 mm²
Increased stripping range
24-5 AWG



Green Line®



www.weicon-tools.com

V 1.22

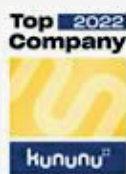

Management System
ISO 9001:2015
ISO 14001:2015
www.tuv.com
ID 9108636595



**FAMILY BUSINESS
SINCE 1947**

We develop, produce and distribute an extensive range of stripping tools. This includes cable knives, wire strippers, dismantling and multi-functional tools. Our tools have been developed for accurate, fast and safe stripping of all common cable types. They carry the GS seal of TÜV Nord and were developed under the aspects of work safety. The tools are specifically tailored to the needs of professional users, are found in both, crafts and industrial use, and are also suitable for domestic use.

Besides the WEICON TOOLS, WEICON produces special chemo-technical products for the industry. Our product range includes special adhesives and sealants, technical sprays as well as high performance assembly pastes and greases for all areas of industry – from the production, repair and maintenance to servicing.

The company headquarters are located in Muenster, Germany. WEICON has subsidiaries in Dubai, Canada, Turkey, Romania, South Africa, Singapore, the Czech Republic, Spain and in Italy and is represented by WEICON partners in more than 120 countries all over the world.



Fast and individual service



Strong sales support



Next day delivery





Management System
ISO 9001:2015
ISO 14001:2015
www.tuv.com
ID 9108636595

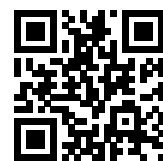

FACHVERBAND WERKZEUGINDUSTRIE e.V.

Member of the Association of German Tool Manufacturers



For more information on all WEICON products, visit www.weicon.com

Content	Page
WEICON TOOLS.....	4
NEW Green Line.....	6
Cable Strippers	8
• No. S 4-28.....	9
• No. S 4-28 Multi.....	9
• No. C 4-16.....	11
• No. C 8-27.....	11
• No. C 4-28.....	11
• No. 4-16.....	11
• No. 8-27.....	11
• No. 4-28 H.....	11
• No. 4-28 G.....	11
• No. 28-35.....	11
• No. 35-50.....	11
Wire Strippers	12
NEW • No. 5 Pro.....	12
• No. 5.....	14
• No. 5 Classic.....	15
• No. 6.....	15
• No. 7 Magic.....	16
• No. 7-F.....	17
• Precision Wire Stripper S.....	18
• ESD Precision Wire Stripper.....	19
• Fibre Optic Stripper.....	19
Stripping Tools	20
• Round Cable Stripper No. 13.....	20
• Round Cable Stripper No. 13 Classic.....	20
• Quadro-Stripper No. 16.....	21
• Combi-Coax No. 3.....	21
• Coax-Stripper No. 1 F Plus.....	22
• Coax-Stripper No. 2.....	23
NEW • LWL Fibre Tube No. 2.....	23
NEW • Profibus Stripper No. 2.....	23
• Cat Cable-Stripper No. 10.....	24
• Stripper No. 2 Cat.....	25
Multi-Purpose Strippers	26
• Mini-Duo No. 150.....	26
• Duo-Stripper No. 200.....	26
• Duo-Crimp No. 300.....	27
• Multi-Stripper No. 400.....	28
• Data-Strip No. 30.....	29
• Stripper No. 100.....	29
Tool Sets	30
• Starter-Set Pro.....	30
• Crimp-Set Pro.....	31
• Electrical Installation Sets.....	32
Special Tools	34
• Mini-Solar No. 3.....	34
• Wire Stripper No. 7 Solar.....	34
• LSA Sensor No. 40.....	35
• Cable Scissors No. 35.....	35
• Cable Stripper No. 4-29 Spiral.....	36
• H.D. No. 1000.....	36
• Dismantling Tool No. 25.....	36
• Multi-Opener.....	37
• Easy Opener®.....	37
Other	38
Spare Parts.....	38
Certificates.....	39
Stripping Tools for Private Label.....	39
Cable Overview.....	40
Application Examples.....	42
Selling Aids.....	44
Product Overview.....	46



Scan your way to the video!

You will find QR codes on our product pages that lead directly to our application videos!

With kind support from





Discover our
WEICON TOOLS®



Quality and continuity "Made in Germany"
INNOVATIVE AND RELIABLE!

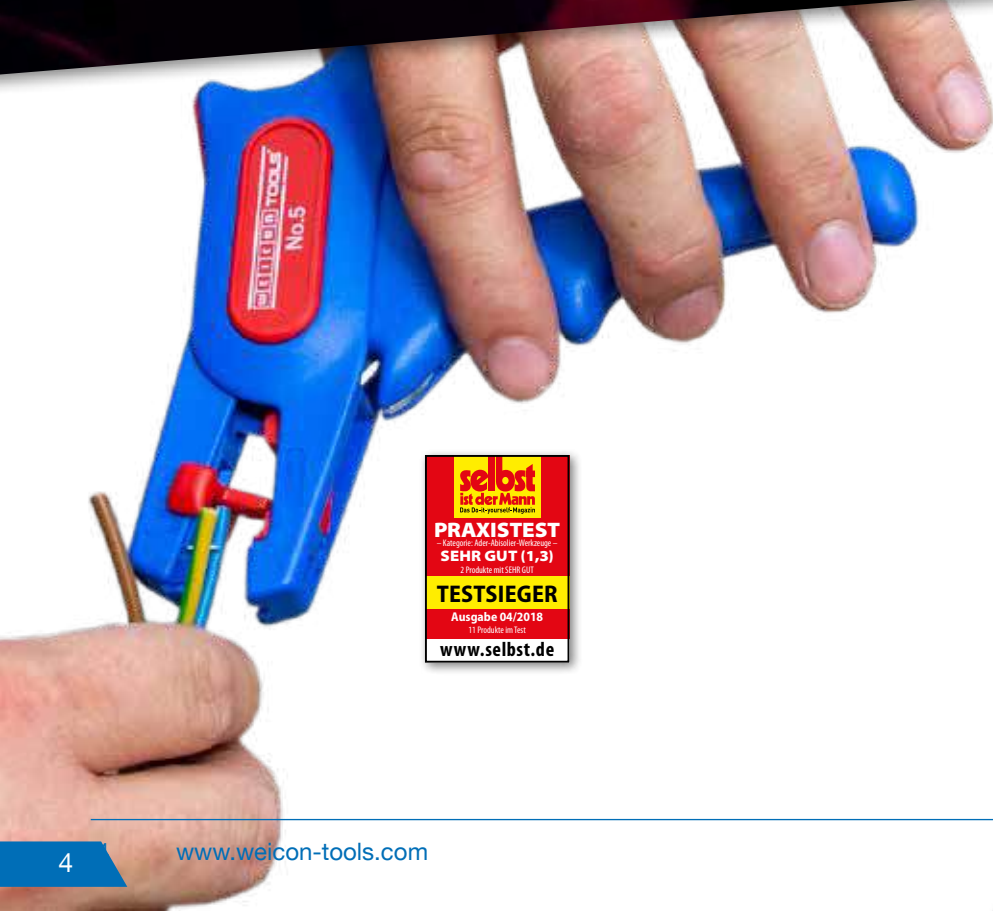

selbst
ist der Mann
Das Online-Magazin
PRAXISTEST
- Kategorie: Handwerk -
SEHR GUT (1,4)
2 Produkte mit SEHR GUT
EMPFEHLUNG
Ausgabe 04/2018
7 Produkte im Test
www.selbst.de

selbst
ist der Mann
Das Online-Magazin
PRAXISTEST
- Kategorie: Handwerk -
SEHR GUT (1,3)
2 Produkte mit SEHR GUT
TESTSIEGER
Ausgabe 04/2018
11 Produkte im Test
www.selbst.de



WEICON TOOLS®



Member of the German Tool Industry Association



We develop, manufacture and distribute high-quality wire stripping and other special tools for the industry and professional users and can look back on almost 50 years of success by now.

We present these tools at more than 40 fairs and trade shows every year, all over the world. We keep in constant contact with our users, who tell us about new developments in their work processes and, that way, give us ideas and requests for new or improved WEICON TOOLS. This exchange of information generates a process that regularly results in product innovations and modifications and therefore enables us to constantly offer our customers the perfectly engineered and up-to-date solutions they need.



In the development of our high-quality stripping tools, we have been working together with the company Krampe from Ascheberg-Herbern near Muenster since 1990.

Our consistent key focus in the production process is on precision to ensure that the products we offer are always of exceptional quality.

Our products are made of high-quality materials, hold numerous certificates and are characterised by their outstanding functionality and durability.



Green Line®

What is Green Line?

Not just a **GREEN** look

Together with a group of experts, we have developed the **WEICON TOOLS Green Line®**. A tool range made of up to 97 % renewable raw materials, which is recyclable and has an excellent life cycle assessment.

97%
made from renewable resources



Eco-friendly quality

What can we do to enable a sustainable future? That is a question not only many people ask themselves in regards to their own homes, but also more and more companies. We at WEICON have also been tackling this issue for many years.

That is why we have developed the **WEICON TOOLS Green Line®**. In terms of quality, they are in no way inferior to our classic line and are just as robust and durable.



The material used:

- ▶ is based on plant oils, natural waxes, fibres and minerals
- ▶ goes through a closed CO₂ cycle and is recyclable
- ▶ is largely produced without the use of the finite resource crude oil
- ▶ has polyamide-like characteristics
- ▶ is produced CO₂ neutrally and with renewable energy





Sustainable Stripping Tools

Cable Strippers | Wire Strippers | Multifunctional Stripping Tools



Cable Stripper No. S 4-28
Art.-No. 53055328



Wire Stripper No. 5
Art.-No. 54000005



Coax-Stripper No. 1 F Plus
Art.-No. 55000001

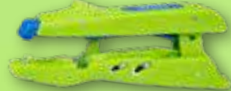

Duo-Crimp No. 300
Art.-No. 54000300



Cable Stripper No. S 4-28 Multi
Art.-No. 53057328



Coax-Stripper No. 2
Art.-No. 55000002

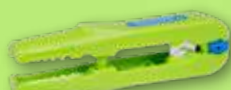

Multi-Stripper No. 400
Art.-No. 54000400



Cable Stripper No. 4-28 H
Art.-No. 53054128



Precision Wire Stripper S
Art.-No. 54000002



Quadro-Stripper No. 16
Art.-No. 55000016



Stripper No. 100
Art.-No. 54000100



Cable Stripper No. 8-27
Art.-No. 53051227



Round Cable Stripper No. 13
Art.-No. 55000013



Starter Set Pro
Art.-No. 55880001



Cable Stripper No. 4-16
Art.-No. 53051116



Production with energy generated in-house

Our tools are produced almost entirely with energy generated in-house – thanks to photovoltaic systems.



Green electricity

At our headquarters in Germany, we now rely on 100 % green electricity.



Cardboard instead of plastic

Our WEICON TOOLS come in a recyclable cardboard packaging.



Resource-saving production chain

Faulty tools as well as the sprue produced during injection moulding are remelted at the beginning of the production chain.



Repairing instead of replacing

Our WEICON TOOLS are part of the WEICON company – a producer of special chemical products for industrial use. Chemicals and sustainability are incompatible? Not necessarily. With the help of our products, many things can be repaired instead of thrown out and replaced.



Discover our
WEICON TOOLS®



CABLE STRIPPERS S 4-28

- ▶ completely ergonomic & fully insulated
- ▶ continuous regulation and easy to operate adjusting wheel
- ▶ precise, quick and safe stripping

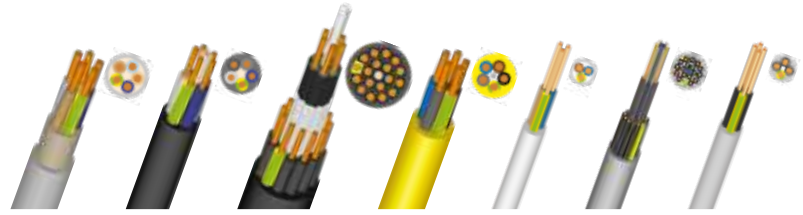

Working range
4-28 mm Ø

EU.Pat.no. 07114242.6

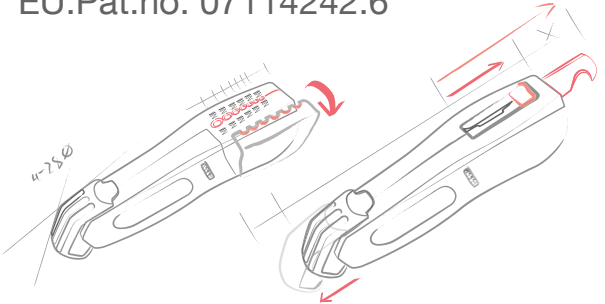

”

Our S 4-28 range is certainly something special. There are no other comparable tools on the market. The right cable stripper can be found for almost any application area thanks to the different types.

Its extraordinary shape ensures a safe and comfortable grip. Furthermore, the retractable blade of the S 4-28 is a milestone in the area of safety at work.

Gerold Specking
Product Manager
WEICON TOOLS

“



No. S 4-28 Multi

Stripping function integrated in the housing

- ▶ stripping of all standard flexible and solid cables with a cross-diameter between 0.5 and 6 mm²



mm	g	mm ²	Ømm	Art.-No.	Green Line (s. page 6)
145	61	0.5-6 (20-10 AWG)	4-28	50057328	53057328

No. S 4-28

Safe due to retractable hook blade

- ▶ the blade can be locked in both positions



mm	g	mm ²	Ømm	Art.-No.	Green Line (s. page 6)
145	72	-	4-28	50055328	53055328

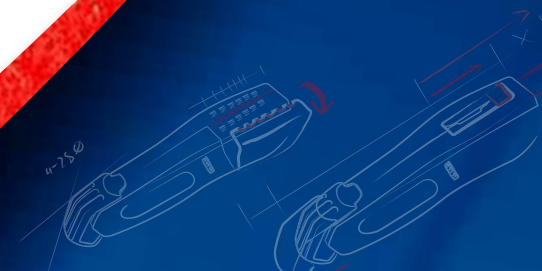

CABLE STRIPPERS

- ▶ completely ergonomic & fully insulated
- ▶ continuous regulation and easy to operate adjusting wheel
- ▶ precise, quick and safe stripping

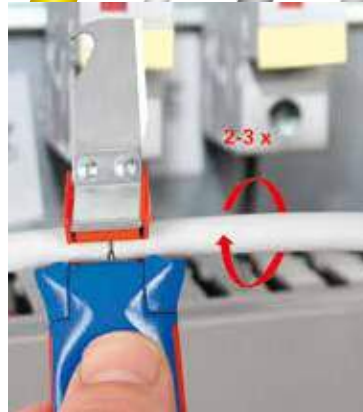

- ① Setting screw
- ② Inner blade
- ③ Bracket with or without blade
- ④ POM part
- ⑤ Cap (on cable stripper with blade)
- ⑥ Outer casing with anti-slip 2-component handle
- ⑦ Closure cap

Cable Strippers

	↔ mm	g	Ømm	Art.-No.
No. 4-16	140	84	4-16	50050116
No. 8-27	140	92	8-28	50050227
	↔ mm	g	Ømm	Art.-No.
No. 4-28 H	185	98	4-28 with hook blade	50054328
	↔ mm	g	Ømm	Art.-No.
No. 4-28 G	195	104	4-28 with straight blade	50054428
	↔ mm	g	Ømm	Art.-No.
No. 28-35	170	87	28-35	50050435
No. 35-50	180	90	35-50	50050450



Cable Strippers

	↔ mm	g	Ømm	Art.-No.	Green Line (s. page 6)
No. C 4-16	135	67	4-16	50053116	53051116
No. C 8-27	135	69	8-28	50053227	53051227
No. C 4-28	180	80	4-28 with hook blade	50053328	53054128



No. C 4-16



No. C 8-27



No. C 4-28

WIRE STRIPPERS

Automatic wire strippers for all common stranded and solid conductors. A scanning system adjusts automatically to the respective wire diameter, and thus permits fast and simple dismantling and stripping.

No. 5 Pro **NEW**

large, efficient working range from 0.2-16 mm² (24-5 AWG) | fully automatic, self-adjusting wire stripper

- ▶ precise working thanks to adjustable length stop (5-25 mm)
- ▶ powerful integrated side cutter up to 3 mm Cu/AL
- ▶ ergonomically designed anti-slip multi-component handle



mm	g	mm ²	Art.-No.
160	140	0.2-16 mm ² 24-5 AWG	51005005

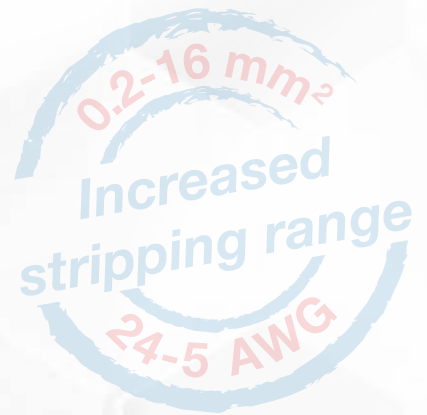

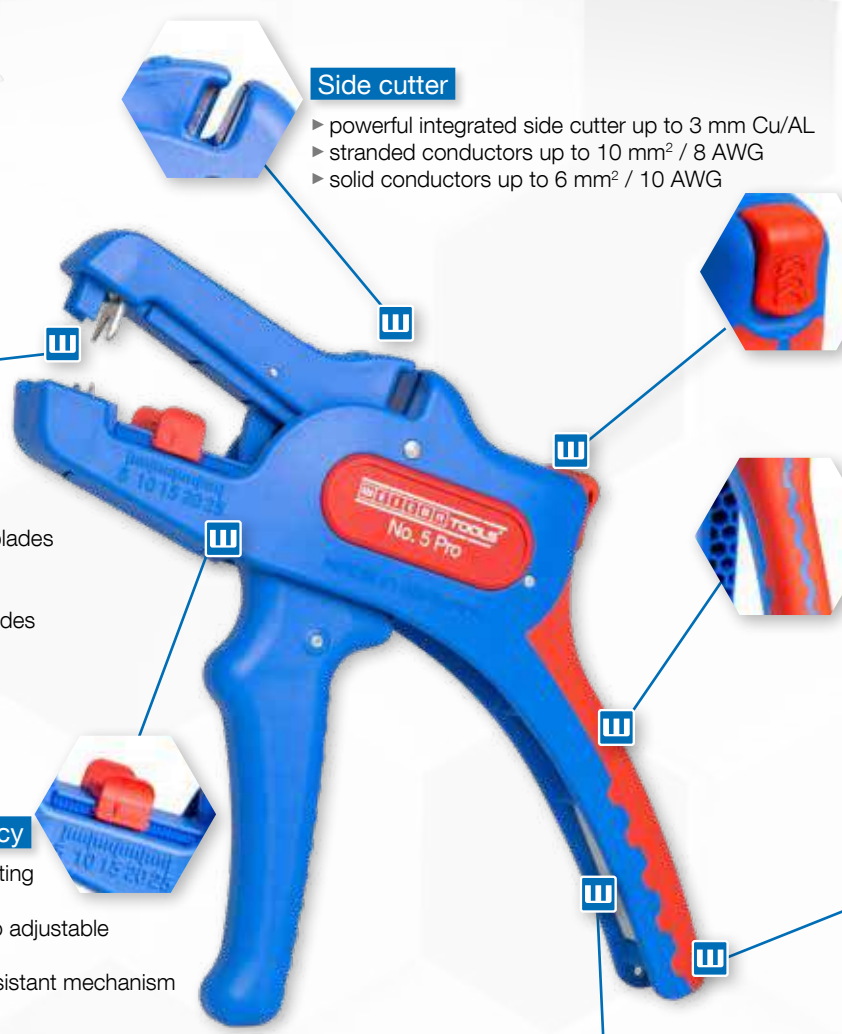

Side cutter

- ▶ powerful integrated side cutter up to 3 mm Cu/AL
- ▶ stranded conductors up to 10 mm² / 8 AWG
- ▶ solid conductors up to 6 mm² / 10 AWG

Safety

- ▶ locking mechanism for safe storage
- ▶ space-saving thanks to detent

High performance

- ▶ modular, exchangeable blades
- ▶ new stripping range from 0.2-16 mm² (24-5 AWG)
- ▶ galvanised, hardened blades

Design and ergonomics

- ▶ 2-component handle with "ice crack" design
- ▶ maximum force transmission
- ▶ ergonomic and non-slip
- ▶ optimum haptic

Precision and efficiency

- ▶ fully automatic, self-adjusting wire stripper
- ▶ precise working thanks to adjustable length stop (5-25 mm)
- ▶ smooth-running, wear-resistant mechanism

Protection

- ▶ integrated eyelet for attaching a drop guard

Individualisation

- ▶ optional customisation of the tool with an individual name or designation

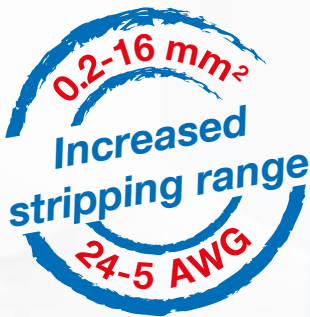

Working Range Wire Strippers:

Outside diameter in mm	0.0123	0.1270	0.0161	0.1430	0.0200	0.1600	0.0252	0.1800	0.0320	0.2020	0.0400	0.2270	0.0503	0.2550	0.0646	0.2860	0.0804	0.3210	0.1020	0.3610	0.1280	0.4050	0.1630	0.4550	0.2050	0.5110	0.2590	0.5730	0.3240	0.6440	0.4120	0.7230	0.5190	0.8120	0.6630	0.9120	0.8230	1.0240	1.04	1.15	1.31	1.29	1.65	1.45	2.08	1.63	2.63	1.83	3.31	2.05	4.15	2.30	5.26	2.59	6.62	2.91	8.34	3.26	10.6	3.67	13.3	4.11	16.8	4.62	21.2	5.19	26.7	5.83	33.6	6.54	42.4	7.35	53.4	8.25
Cross section in mm ²	0.0123	0.1270	0.0161	0.1430	0.0200	0.1600	0.0252	0.1800	0.0320	0.2020	0.0400	0.2270	0.0503	0.2550	0.0646	0.2860	0.0804	0.3210	0.1020	0.3610	0.1280	0.4050	0.1630	0.4550	0.2050	0.5110	0.2590	0.5730	0.3240	0.6440	0.4120	0.7230	0.5190	0.8120	0.6630	0.9120	0.8230	1.0240	1.04	1.15	1.31	1.29	1.65	1.45	2.08	1.63	2.63	1.83	3.31	2.05	4.15	2.30	5.26	2.59	6.62	2.91	8.34	3.26	10.6	3.67	13.3	4.11	16.8	4.62	21.2	5.19	26.7	5.83	33.6	6.54	42.4	7.35	53.4	8.25
AWG number	36	35	34	33	32	31	30	29	28	27	26	25	24	23	22	21	20	19	18	17	16	15	14	13	12	11	10	9	8	7	6	5	4	3	2	1	0																																					
Wire Stripper No. 5 Pro	[Red bar]																																																																									
Wire Stripper No. 5	[Red bar]																																																																									
Wire Stripper No. 5 Classic	[Red bar]																																																																									
Wire Stripper No. 6	[Red bar]																																																																									
Wire Stripper No. 7-F	[Red bar]																																																																									
Precision Wire Stripper S	[Red bar]																																																																									
ESD Precision Wire Stripper	[Red bar]																																																																									
Fibre Optic Stripper	[Blue bar]																																																																									

WIRE STRIPPERS

**Our
Bestseller**

No. 5

Space-saving thanks to locking mechanism

- ▶ automatic wire stripper
- ▶ precise work with adjustable length stop (5-12 mm)
- ▶ integrated, well accessible side cutter up to 2 mm Ø

mm	g	mm ²	Ømm	Art.-No.	Green Line (s. page 6)
170	107	0.2-6 (24-10 AWG)		51000005	54000005

**selbst
ist der Mann**
Das Do-it-yourself-Magazin

PRAXISTEST
- Kategorie: Ader-Abisolier-Werkzeuge -
SEHR GUT (1,3)
2 Produkte mit SEHR GUT

TESTSIEGER

Ausgabe 04/2018
11 Produkte im Test

www.selbst.de





No. 5 Classic

mm	g	mm ²	Ømm	Art.-No.
170	107	0.2-6 (24-10 AWG)		51003005



No. 6

Working with voltage up to 1000 Volt*
Unit testing according to DIN EN 60900

- ▶ fully insulated, automatic wire stripper
- ▶ precise work with adjustable length stop (5-12 mm)
- ▶ space-saving thanks to locking mechanism

mm	g	mm ²	Ømm	Art.-No.
170	105	0.2-6 (24-10 AWG)	-	51000006

* Tools with safety insulation are basic prerequisites for working on live wires and parts. Please always pay attention to the legal regulations and follow the corresponding safety advice!



1.000 V
IEC: 60900



Working Range Wire Strippers:

	36	35	34	33	32	31	30	29	28	27	26	25	24	23	22	21	20	19	18	17	16	15	14	13	12	11	10	9	8	7	6	5	4	3	2	1	0		
Outside diameter in mm	0.123	0.127	0.143	0.160	0.180	0.202	0.227	0.255	0.286	0.321	0.361	0.405	0.455	0.511	0.573	0.644	0.723	0.812	0.912	1.024	1.15	1.29	1.45	1.63	1.83	2.05	2.30	2.59	2.91	3.26	3.67	4.11	4.62	5.19	5.83	6.54	7.35	8.25	
Cross section in mm ²	0.0123	0.0161	0.0200	0.0252	0.0320	0.0400	0.0503	0.0646	0.0804	0.1020	0.1280	0.1630	0.2050	0.2590	0.3240	0.4120	0.5190	0.6630	0.8230	1.04	1.31	1.65	2.08	2.63	3.31	4.15	5.26	6.62	8.34	10.6	13.3	16.8	21.2	26.7	33.6	42.4	53.4		
AWG number	36	35	34	33	32	31	30	29	28	27	26	25	24	23	22	21	20	19	18	17	16	15	14	13	12	11	10	9	8	7	6	5	4	3	2	1	0		
Wire Stripper No. 5 Pro																																							
Wire Stripper No. 5																																							
Wire Stripper No. 5 Classic																																							
Wire Stripper No. 6																																							
flexible																																							
Wire Stripper No. 7 Magic																																							
solid																																							
outer sheath																																							
Wire Stripper No. 7-F																																							
Precision Wire Stripper S																																							
ESD Precision Wire Stripper																																							
Fibre Optic Stripper																																							

WIRE STRIPPERS

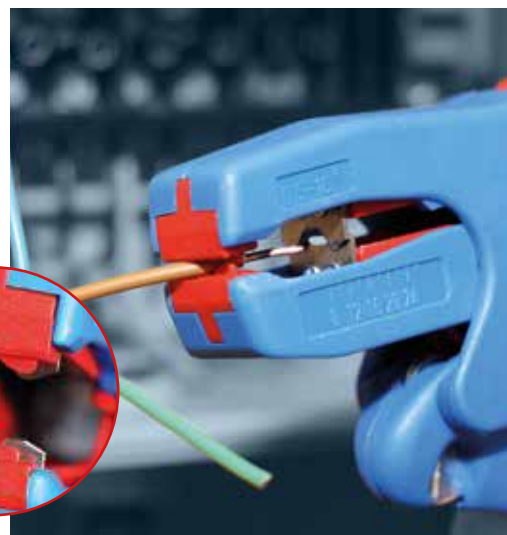

No. 7 *Magic*

The all-rounder for stripping and dismantling
Pat.no. EP 1 671 407 B1

- ▶ for many different cable types in building installation
- ▶ precise work with optical length scale
- ▶ integrated, well accessible side cutter up to 3 mm Ø

mm	g	Round cables	mm ²	Art.-No.
170	217	flexible solid	0.5-6 (20-6 AWG) 0.5-10 (20-8 AWG)	51000007

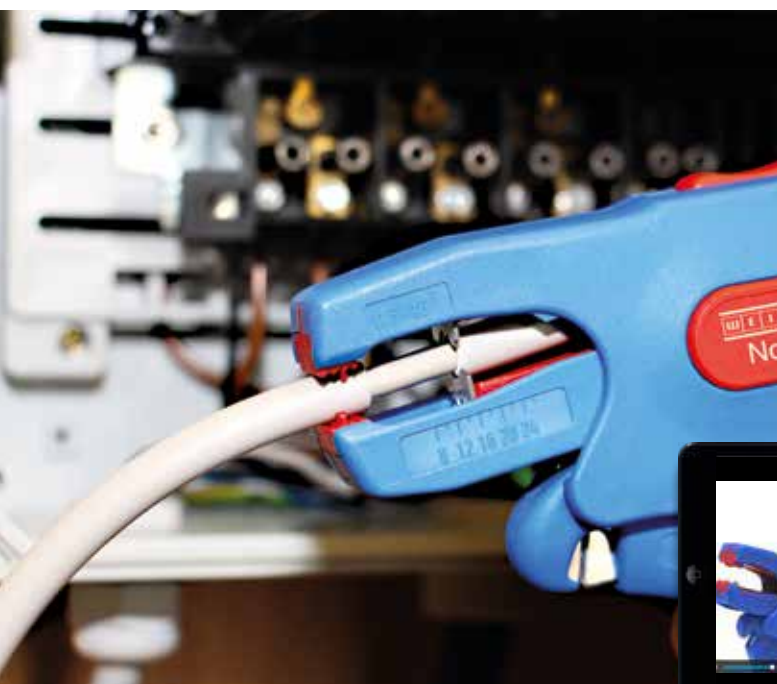

VIDEO





No. 7-F

Stripping and dismantling of all standard flat cables
Pat.no. EP 1 671 407 B1

- ▶ precise work with optical length scale
- ▶ integrated, well accessible side cutter up to 3 mm Ø



mm	g		mm ²	Art.-No.
170	220	flat cables	0.75-4 (18-11 AWG)	51001007



Working Range Wire Strippers:

Outside diameter in mm	0.123	0.1270	0.161	0.1450	0.200	0.1600	0.252	0.1800	0.320	0.2020	0.400	0.2270	0.503	0.2550	0.646	0.2860	0.804	0.3210	1.020	0.3610	1.280	0.4050	1.630	0.4550	2.050	0.5110	2.590	0.5730	3.240	0.6440	4.120	0.7230	5.190	0.8120	6.630	0.9120	8.230	1.0240	1.04	1.15	1.31	1.29	1.65	1.45	2.08	1.63	2.63	1.83	3.31	2.05	4.15	2.30	5.26	2.59	6.62	2.91	8.34	3.26	10.6	3.67	13.3	4.11	16.8	4.62	21.2	5.19	26.7	5.83	33.6	6.54	42.4	7.35	53.4	8.25
Cross section in mm ²	0.0123	0.1270	0.0161	0.1450	0.0200	0.1600	0.0252	0.1800	0.0320	0.2020	0.0400	0.2270	0.0503	0.2550	0.0646	0.2860	0.0804	0.3210	0.1020	0.3610	0.1280	0.4050	0.1630	0.4550	0.2050	0.5110	0.2590	0.5730	0.3240	0.6440	0.4120	0.7230	0.5190	0.8120	0.6630	0.9120	0.8230	1.0240	1.04	1.15	1.31	1.29	1.65	1.45	2.08	1.63	2.63	1.83	3.31	2.05	4.15	2.30	5.26	2.59	6.62	2.91	8.34	3.26	10.6	3.67	13.3	4.11	16.8	4.62	21.2	5.19	26.7	5.83	33.6	6.54	42.4	7.35	53.4	8.25
AWG number	36	35	34	33	32	31	30	29	28	27	26	25	24	23	22	21	20	19	18	17	16	15	14	13	12	11	10	9	8	7	6	5	4	3	2	1	0																																					
Wire Stripper No. 5 Pro																																																																										
Wire Stripper No. 5																																																																										
Wire Stripper No. 5 Classic																																																																										
Wire Stripper No. 6																																																																										
Wire Stripper No. 7 Magic	flexible																																																																									
	solid																																																																									
	outer sheath																																																																									
Wire Stripper No. 7-F																																																																										
Precision Wire Stripper S																																																																										
ESD Precision Wire Stripper																																																																										
Fibre Optic Stripper																																																																										



reddot winner 2020



DBGM 20 2019 107 281.4

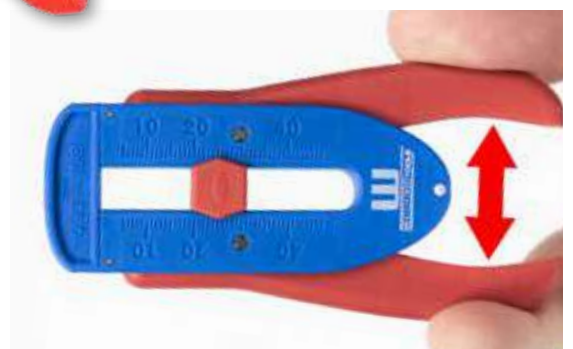

Precision Wire Stripper S

Fast, easy and precise stripping of thin wires and conductors

- ▶ stripping range from 0.12-0.8 mm (36-20 AWG)
- ▶ scanning system adjusts automatically to the required wire diameter
- ▶ precise working thanks to adjustable length stop from 5 - 45 mm
- ▶ professional stripping technology, suitable for right- and left-handed users

mm	g	Round cables	Ømm	Art.-No.	Green Line (s. page 6)
112	45	flexible solid	0.12-0.8 0.12-0.8	51000002	54000002

STRIPPING TOOLS

Our stripping tools allow a range of different cables to be safely and conveniently stripped. The flexible tools can even be reliably used in hard-to-reach areas and always provide precise results.

Round Cable Stripper No. 13

Safe work with the ergonomic anti-slip handle shape

- ▶ for all standard round cables
- ▶ flush stripping, even in hard-to-reach areas
- ▶ it is not necessary to adjust the cutting depth

mm	g	mm ²	Ømm	Art.-No.	Green Line (s. page 6)
140	48	-	6-13	52000013	55000013

Now with
length stop

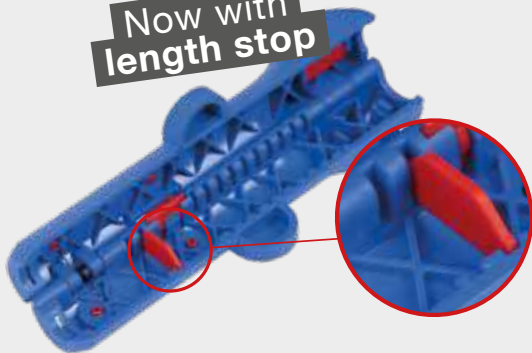

Increased
stripping range
6-13 mm



Round Cable Stripper No. 13 Classic

Safe work with the ergonomic anti-slip handle shape

- ▶ for all standard round cables
- ▶ flush stripping, even in hard-to-reach areas
- ▶ it is not necessary to adjust the cutting depth

mm	g	mm ²	Ømm	Art.-No.
120	44	-	8-13	52003013



Quadro-Stripper No. 16

Multifunctional with optimised cable routing

- ▶ circular and longitudinal cutting - stripping - cutting
- ▶ exchangeable hook blade, firmly locked in any position
- ▶ anti-slip handle shape

mm	g	mm ²	Ømm	Art.-No.	Green Line (s. page 6)
125	53	0.5-6 (20-10 AWG)	8-13	52000016	55000016

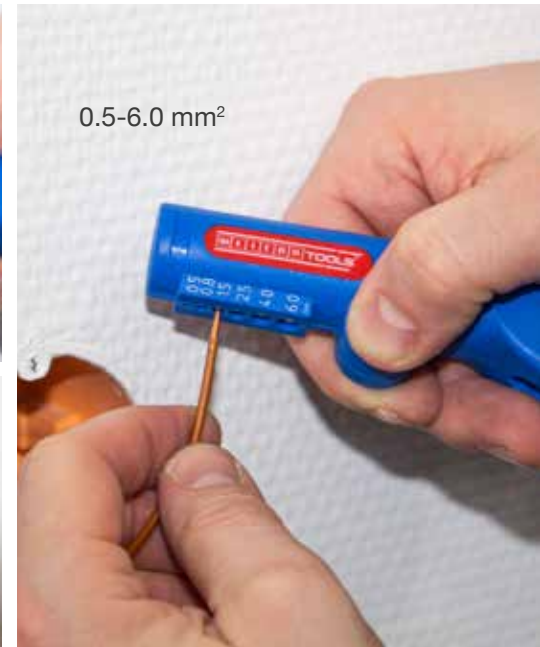
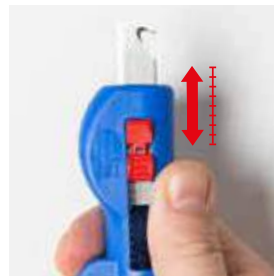
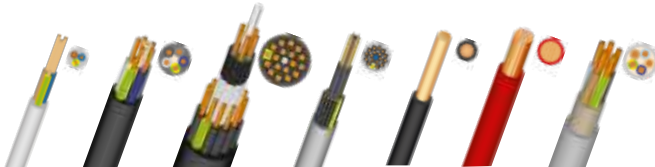

Combi-Coax No. 3

Parallel blade arrangement allows even faster stripping

- ▶ allows two- or three-level stripping of all common coaxial cables
- ▶ also suitable for flexible cables
- ▶ integrated and well accessible side cutter up to 8 mm Ø

mm	g	mm ²	Ømm	Art.-No.
125	55	-	4.8-7.5	52000003



STRIPPING TOOLS

Coax-Stripper No. 1 F Plus



Quick dismantling and stripping of coaxial cables with only one working step

- ▶ space-saving assembly and disassembly of F-connectors due to integrated open hexagon wrench with 11 mm width across flats
- ▶ gripping jaws for screwing F-connectors onto the cable
- ▶ changeable module inserts via click system



DBGM 20 2017 107 094



mm	g		Ømm	Art.-No.	Green Line (s. page 6)
125	47	for compression connectors	6.0-8.0	52001001	
125	47	for F-screw connectors	6.0-8.0	52000001	55000001
125	47	for compression connectors*	4.0-5.0	52002001	

*for mini coaxial cables

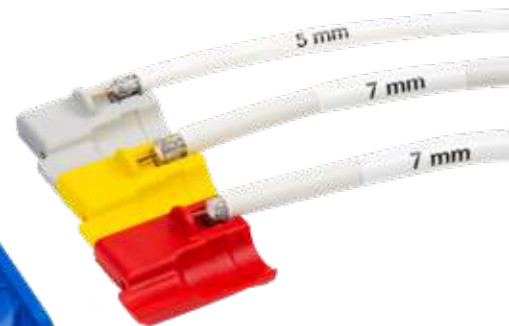

Coax-Stripper No. 2

Good handling due to ergonomic design

- ▶ two-level stripping of all common coaxial cables
- ▶ there is no need to adjust the cutting depth
- ▶ also suitable for flexible cables
- ▶ length scale (0-17 mm) integrated in the housing

mm	g	mm ²	Ømm	Art.-No.	Green Line (s. page 6)
110	28	-	4.8-7.5	52000002	55000002

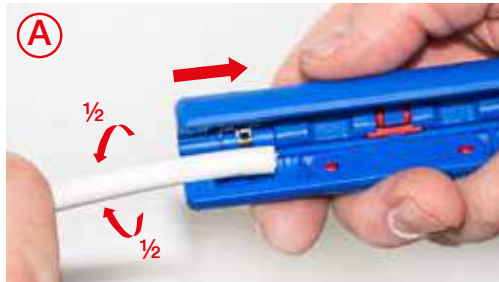
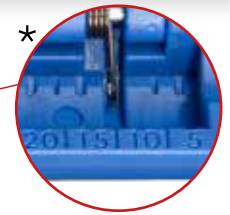

Fibre Optic Tube No. 2 NEW

Tool for stripping special buffer tubes on fibre optic cables with a diameter of 1.2 mm - 4 mm. Works with core sleeves, e.g. made of PE, with wall thicknesses of 0.15 mm - 0.6 mm.

- ▶ precisely cuts the PE tubes on fibre optic cables
- ▶ fast stripping of the loose tubes
- ▶ modular pair of blades for fibre optic tubes

mm	g	mm ²	Ømm	Art.-No.
110	36	-	-	52003002



Profibus Stripper No. 2 NEW

Stripping tool for e.g. shielded Profibus data cables with a diameter of 5.5 mm to 8 mm, e.g. installing for FastConnect connectors

- ▶ cut optimised for FastConnect connectors
- ▶ optical length scale optimised for different connector types
- ▶ modular pair of blades for Profibus

mm	g	mm ²	Ømm	Art.-No.
110	35	-	5.5-8.0	52004002

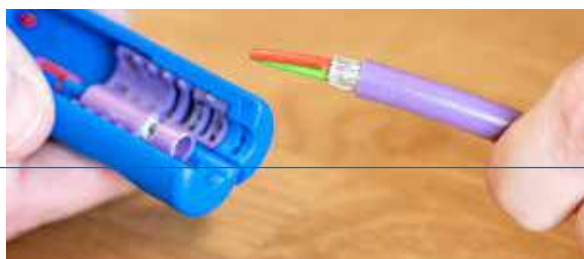

STRIPPING TOOLS

Cat Cable-Stripper No. 10

Easy and space-saving stripping of data and network cables

- ▶ suitable for e.g. Cat5, Cat6, Cat7 twisted-pair cables (4.5-10 mm Ø)
- ▶ integrated length stop, adjustable to the required length
- ▶ safe work with the ergonomic anti-slip handle shape

mm	g	mm ²	Ømm	Art.-No.
140	48	-	4.5-10	52000010

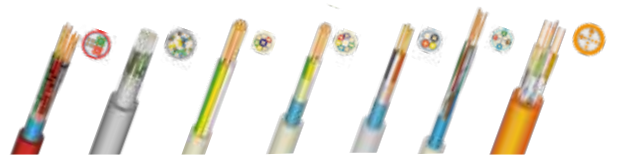
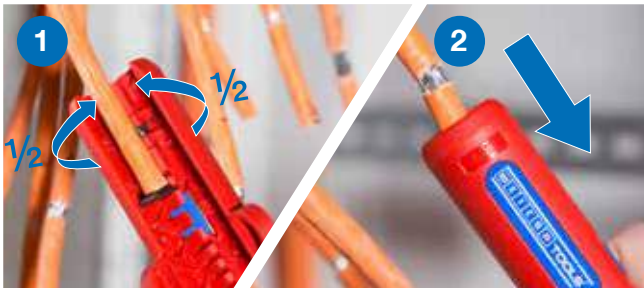

**IDEAL
HANDLE SHAPE**



Stripper No. 2 Cat

Easy handling thanks to ergonomic shape

- ▶ for insulated PVC data cables (e.g. Cat5, Cat6, Cat7, twisted-pair cables) with a diameter of 4.5-10 mm
- ▶ adjusting the cutting depth manually is not necessary
- ▶ the precise adjustment of the blade removes the outer jacket accurately; with the second blade, the foil shield is slit open carefully and can then be easily removed



mm	mm ²	Ømm	Art.-No.
110 28	-	4.5-10	52002002

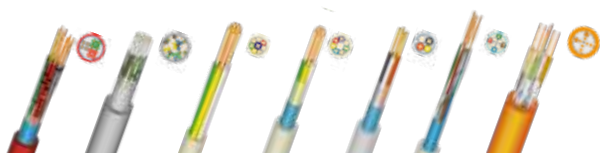
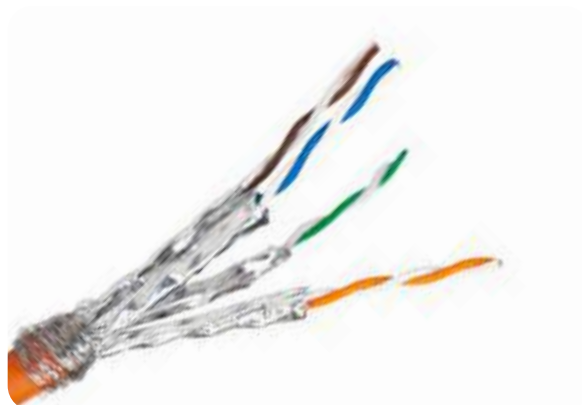
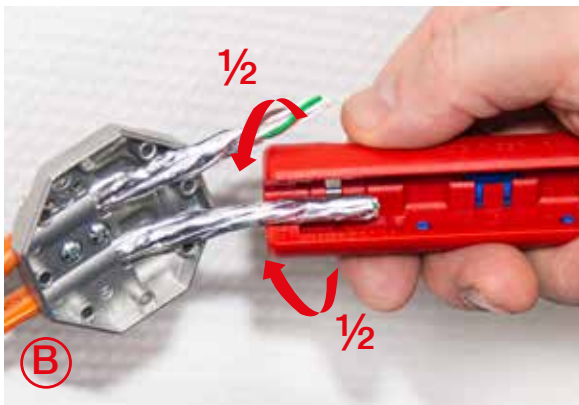
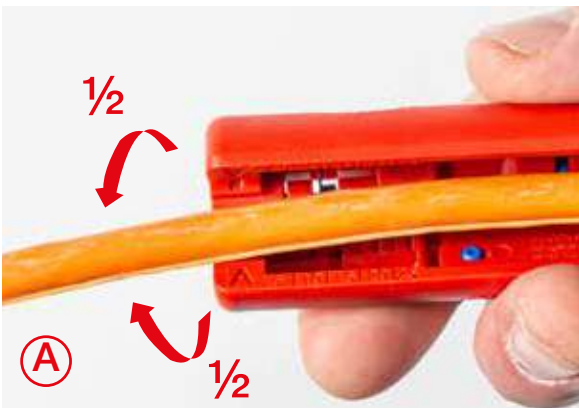

MULTI-PURPOSE STRIPPERS



Mini-Duo No. 150

Automatic wire stripper

- ▶ allows quick and accurate stripping
- ▶ precise work with integrated length scale
- ▶ easily accessible built-in side cutter for cables up to 6 mm²

↔ mm	g	mm ²	Ømm	Art.-No.
160	112	0.5-6 (20-10 AWG)	-	51000150



Duo-Stripper No. 200

Professional dismantling and stripping

- ▶ quick and simple stripping from 0.5 mm² to 6.0 mm²
- ▶ dismantling: working range 4-28 mm Ø
- ▶ spare blade in the handle case

↔ mm	g	mm ²	Ømm	Art.-No.
160	123	0.5-6 (20-10 AWG)	4-28	51000200



VIDEO



Duo-Crimp No. 300

Abisolieren und Crimpen mit nur einem Werkzeug

- ▶ insulation removal from 0.5 mm² to 6.0 mm²
- ▶ two crimping ranges are offered (0.5-2.5 mm² and 4.0-6.0 mm²) according to DIN 46228-2
- ▶ integrated, well accessible side cutter up to 6 mm²

mm		mm ²	Ømm	Art.-No.	Green Line (s. page 6)
160	116	0.5-6 (20-10 AWG)	-	51000300	54000300



STRIPPING + CRIMPING

MULTI-PURPOSE STRIPPERS

Multi-Stripper No. 400

Multifunctional with 4 functions

- ▶ circular cutting - longitudinal cutting - stripping - cutting
- ▶ flush stripping, even in hard-to-reach areas
- ▶ safe and space-saving storage with closing clip



mm	g	mm ²	Ømm	Art.-No.	Green Line (s. page 6)
155	79	0.5-6 (20-10 AWG)	8-13	51000400	54000400



**selbst
ist der Mann**
Das Do-it-yourself-Magazin

PRAXISTEST
- Kategorie: Entmantler -
SEHR GUT (1,4)
2 Produkte mit SEHR GUT

EMPFEHLUNG

Ausgabe 04/2018
7 Produkte im Test

www.selbst.de

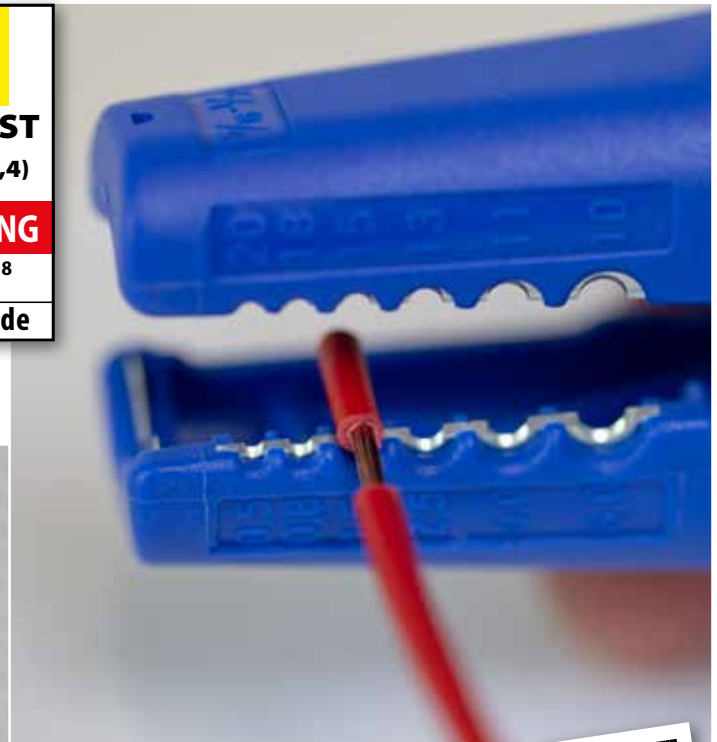

VIDEO

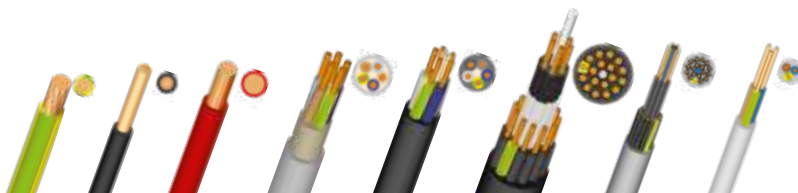



Data-Strip No. 30

Inner blade can be set to the insulation thickness

- ▶ removal of the outer insulation on data cables
- ▶ stripping of conductors and stranded wires, e.g. telephone lines
- ▶ precise stripping with adjustable length stop (3.5-14 mm)
- ▶ integrated, well accessible side cutter up to 8 mm Ø

mm	g	mm ²	Ømm	Art.-No.
125	60	0.05-0.5 (0.2-0.8 Ø) (30-20 AWG)	4-10	52000030

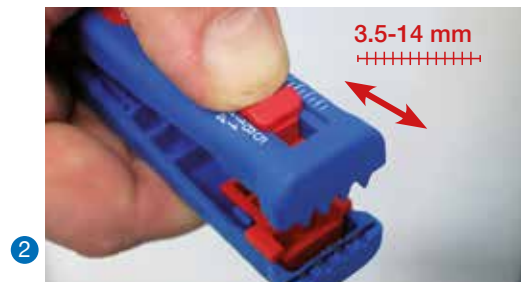
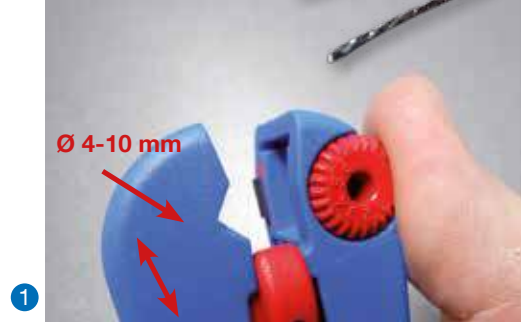
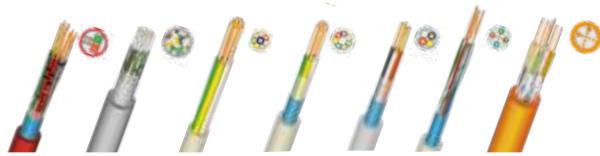

Stripper No. 100

Universal tool for dismantling and stripping

- ▶ for many different cable types in building installation
- ▶ flush stripping on ceilings and walls
- ▶ allows circular and longitudinal stripping

mm	g	mm ²	Ømm	Art.-No.
140	74	0.5-16 (20-6 AWG)	4-13	51000100

Green Line
(s. page 6)
54000100



TOOL SETS

With our tool sets, we can offer solutions for almost all industries and many different applications.

Starter-Set Pro

Ideal selection for home wiring

- ▶ Wire Stripper No. 5
- ▶ Coax-Stripper No. 2
- ▶ Cable Stripper No. S 4-28
- ▶ Round Cable Stripper No. 13

**TOP
SELECTION**



mm Length x Width x Height	g	Art.-No.	Green Line (s. page 6)
255 x 210 x 60	575	52880001	55880001

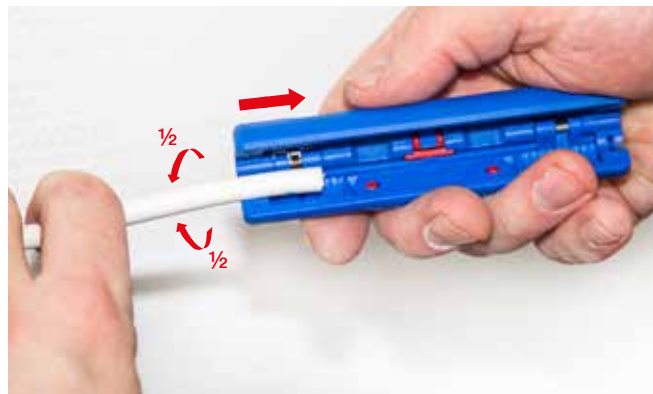

Crimp-Set Pro

All-round equipment for crimping with wire ends

- ▶ Duo-Crimp No. 300
- ▶ Wire Stripper No. 7 Magic
- ▶ high-quality shaker with 400 wire ends (0.5-2.5 mm²) according to DIN 46228

mm Length x Width x Height	g	Art.-No.
340 x 280 x 55	950	52880002



STRIPPING + CRIMPING



Shaker with wire ends

(DIN 46228)

Cross Section	Content	Colour
0.50 mm ²	50	white
0.75 mm ²	100	grey
1.00 mm ²	100	red
1.50 mm ²	100	black
2.50 mm ²	50	blue

TOOL SETS

Electrical Installation Set 1

- ▶ Duo-Crimp No. 300
- ▶ Round Cable Stripper No. 13
- ▶ professional crimping of wire ends
- ▶ two crimping ranges of 0.5-2.5 mm² and 4.0-6.0 mm²
- ▶ meets the requirements of DIN 46228-21: 1992-02 concerning the pull-off forces
- ▶ side cutter for single wires up to 6 mm²
- ▶ stripping of 0.5-6.0 mm²
- ▶ dismantling of all common round cables 6-13 mm
- ▶ flush dismantling e.g. at junction and distribution boxes

Art.-No.

52881001



Electrical Installation Set 2

- ▶ Wire Stripper No. 5
- ▶ Cable Stripper No. S 4-28
- ▶ automatic wire stripper for 0.2-6.0 mm²
- ▶ side cutter for single wires up to 2 mm ø
- ▶ adjustable length stop for defined distances at e.g. WAGO-Clamps
- ▶ cable stripper with working range of 4-28 mm
- ▶ adjustable cutting blade for round and longitudinal cutting
- ▶ ideal for the construction of switchboards

Art.-No.

52881002



Electrical Installation Set 3

- ▶ **Wire Stripper No. 5**
- ▶ **Coax-Stripper No. 2**
- ▶ automatic wire stripper for 0.2-6.0 mm²
- ▶ side cutter for single wires up to 2 mm ø
- ▶ adjustable length stop for defined distances at e.g. connection terminals
- ▶ two-level stripping of all common coaxial cables
- ▶ ideal for the installation of SAT systems with multi switches
- ▶ length scale integrated in the housing, e.g. for F-connectors
- ▶ adjustment of cutting depth not necessary

Art.-No.

52881003



Electrical Installation Set 4

- ▶ **Wire Stripper No. 5**
- ▶ **Round Cable Stripper No. 13**
- ▶ automatic wire stripper for 0.2-6.0 mm²
- ▶ side cutter for single wires up to 2 mm ø
- ▶ adjustable length stop for e.g. special distances
- ▶ dismantling of all common round cables from 6-13 mm
- ▶ flush dismantling, e.g. at junction and distribution boxes

Art.-No.

52881004



SPECIAL TOOLS

For a series of unusual applications, we provide you with special tools which meet these requirements. Whether it is the dismantling of large cable diameters, tools for the solar industry or working on high voltage cables, WEICON TOOLS has the solution!

Especially for the solar sector



Mini Solar No. 3

Special tools for dismantling and stripping of all common cables in the solar sector

- ▶ quick stripping of all common solar cables with outer diameters from 1.5 mm² to 6 mm²
- ▶ precise work with adjustable length stop (6-28 mm)
- ▶ integrated, well accessible side cutter up to 4 mm²

mm	g	mm ²	Ømm	Art.-No.
125	58	1.5-6 (15-9 AWG)	-	52002003



Wire Stripper No. 7 Solar

Special tools for dismantling and stripping of all common cables in the solar sector

- ▶ automatic wire stripper
- ▶ precise work with optical length scale (up to 28 mm)
- ▶ integrated, well accessible side cutter up to 3 mm Ø



mm	g	mm ²	Art.-No.
170	218	Solar cable 1.5-6 (15-9 AWG)	51002007

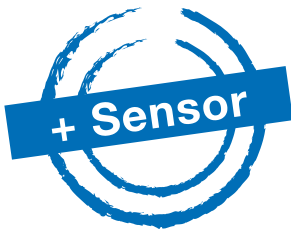

LSA Sensor No. 40

For the solderless, screwless and no-stripping inserting and simultaneously cutting of wire ends into LSA punch-down blocks

- ▶ with built-in retractable hook and unlocking blade
- ▶ for conductor diameters 0.35-0.9 mm and wire diameters 0.7-2.6 mm
- ▶ has a sensor for tracing the wire end position

mm	g	Ømm	Art.-No.
185	60	0.35-0.9	52000040

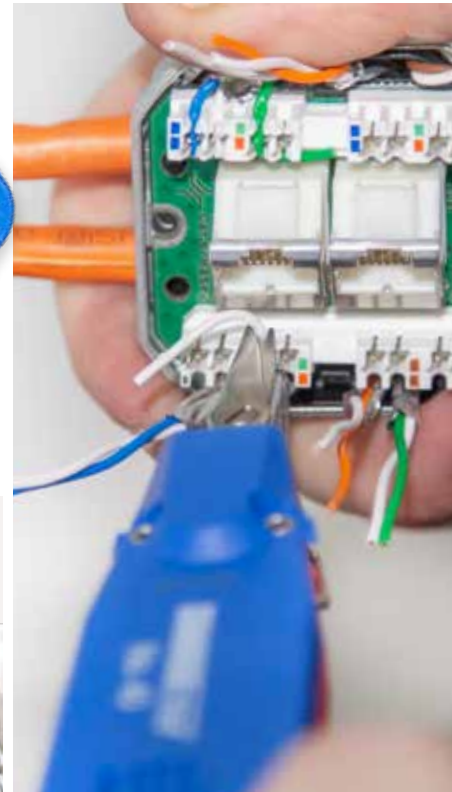

Cable Scissors No. 35

Cutting - stripping - crimping

- ▶ 2-component handles for increased safety
- ▶ high cutting performance
- ▶ blades made of special stainless steel

mm	g	Cu/Al	Cu/Al	Art.-No.
150	90	⊙ < 35 mm ²	⊙ < 50 mm ²	52000035



Including safetybox with belt clip



SPECIAL TOOLS

Cable Stripper No. 4 - 29 Spiral

round, longitudinal and circular cutting for soft and rigid cable insulations

- ▶ for all common round cables from 4.5-29 mm Ø
- ▶ cutting depth can be set comfortably from 0-3 mm with lockable control knob in 0.1 mm steps

mm	g	Ømm	Art.-No.
140	136	4.5-29	52000029



ROUND CUT



SPIRAL CUT



LONGITUDINAL CUT

Cable Stripper H.D. No. 1000

1.000 V
IEC: 60900



Working with voltage up to 1000 Volt*
Unit testing according to DIN EN 60900

- ▶ quick cutting of cables with multiple insulations
- ▶ conductor protection with the curved blade tip
- ▶ good transfer of force due to optimised handle shape

mm	g	Art.-No.
215	93	51001000

*Tools with safety insulation are basic prerequisites for working on live wires and parts.
Please always pay attention to the legal regulations and follow the corresponding safety advice!

Dismantling Tool No. 25

For convenient longitudinal and circular cuts

- ▶ safe working thanks to concealed blade
- ▶ wire protection thanks to rounded blade tip
- ▶ easy working even in low temperatures
- ▶ precise, durable, replaceable turning blade

mm	g	Ømm	mm	Art.-No.
210	163	>25 mm	0-5.0 mm	52000025



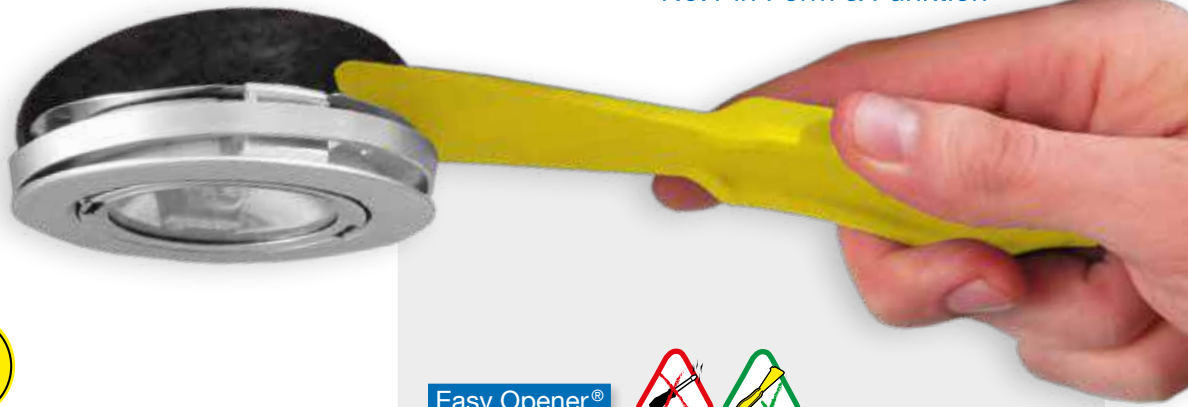

Multi-Opener



The ideal tool for the gentle opening of sensitive equipment and dismounting of clipped housings

- ▶ no scratching of sensitive surfaces
- ▶ dissipative ESD material protects against electrostatic discharge
- ▶ flexible fibreglass-reinforced polyamide
- ▶ stainless steel blade to remove adhesive residues

mm	g	Surface Resistance	Art.-No.
180	22	approx. $10^9 \Omega$	52800000



Easy Opener®



Special tool for the gentle disassembly of sensitive components without damaging the material

- ▶ ideal for loosening switches, luminaires or similar components
- ▶ flexible and stable at the same time
- ▶ three surfaces with different material thickness

mm	g	Art.-No.
180	22	52800001

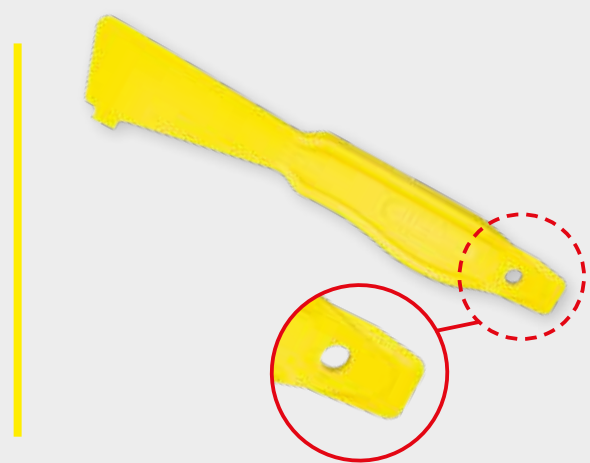

SPARE PARTS

Art. No.	Name	PU	
50100002	Spare blade for Cable Stripper series S 4 - 28 <i>Inner blade</i>	1	
50100001	Spare blade for Cable Strippers <i>Inner blade</i>	1	
51100008	Spare blade for No. 200 <i>Inner blade</i>	1	
51100002	Spare blade set No. 5/No. 6 <i>2 blades + 1 screw</i>	1	
51100012	Spare blade set No. 5 Pro	1	
51100006	Spare blade set No. 7 Magic <i>2 blades + 4 screws</i>	1	
51100007	Spare blade set No. 7-F <i>2 blades + 4 screws</i>	1	
51100005	Spare blade set No. 7 Solar	1	
52953030	Spare blade set No. 30 Data-Strip <i>1 blade + adjusting screw</i>	1	
51953020	Spare blade set for No. 150 / No. 200 / No. 300	1	
52953020	Spare blade for Dismantling Tool No. 25 <i>Double edge blade</i>	1	
52953050	Spare blade for Cable Stripper 4-29 Spiral	1	
52953040	Hook knife for No. 16 <i>1 hook knife 1 slider + 1 screw</i>	1	
52100008	Inserts for No.1 F Plus 6/4	6	
52100009	Inserts for No.1 F Plus 6.5/6.5	6	
52100010	Inserts for No.1 F Plus 6/4	6	
52101001	Module inserts for Fibre Optic Tubes No. 2	1	
52101002	Module inserts for Profibus Stripper No. 2	1	

CERTIFICATES

Distinguished in form & function



Management System
ISO 9001:2015
ISO 14001:2015
www.tuv.com
ID 9108636595



Green Line®

PRIVATE LABEL Tools

We also provide the opportunity to design the tools in a variety of colour combinations and individually with your company print/logo.

We would be pleased to submit a detailed offer.





























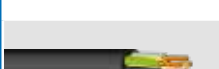







individual colour combinations

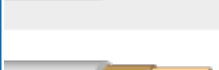

The cable types shown in the table below are only meant to give an overview of the potential application areas of our tools. WEICON TOOLS can also be used on similar cable types in many cases, of course.

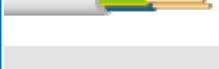
Furthermore, the application suggestions depend on the material, application area and working range. Our tool recommendation is only a suggestion due to the various materials used by cable manufacturers.

CABLE OVERVIEW

Category	Cable	Wire diameter Example type	Name	Suggested application Dismantling	Suggested application Stripping
Installation Lines (solid conductors)		 (N)YM	PVC coated conductor	All Cable Strippers, No. 13, No. 16, No. 100, No. 200, No. 400, No. 7 Magic	No. S 4-28 Multi, No. 5 Pro, No. 5, No. 6, No. 7 Magic, No. 7-F, No. 16, No. 100, No. 400, No. 200
		 NHXMH	Halogen-free sheathed cable (PVC-free)	All Cable Strippers, No. 13, No. 16, No. 100, No. 200, No. 400, No. 7 Magic	No. S 4-28 Multi, No. 5 Pro, No. 5, No. 6, No. 7 Magic, No. 7-F, No. 16, No. 100, No. 400, No. 200
		 NI2XY	Installation line (concrete line)	All Cable Strippers, No. 13, No. 16, No. 100, No. 200, No. 400, No. 7 Magic	No. S 4-28 Multi, No. 5 Pro, No. 5, No. 6, No. 7 Magic, No. 7-F, No. 16, No. 100, No. 400, No. 200
		 H05V-U	PVC single wire core conductor	---	No. S 4-28 Multi, No. 5 Pro, No. 5, No. 6, No. 7 Magic, No. 7-F, No. 16, No. 100, No. 200, No. 400
		 H07V-R	PVC multiple wire core conductor	---	No. S 4-28 Multi, No. 5 Pro, No. 5, No. 6, No. 7 Magic, No. 7-F, No. 100
		 ---	PVC flat twin and earth cable	No. 7-F	No. 7-F
		 ---	Flat rubber cable for medium mechanical loads	No. 7-F	No. 7-F
		 JB-Y(ST)Y	Installation cable for fire alarm systems	No. 2 Cat, No. 10, No. 30	No. 30
Control and Electrical Lines (stranded conductors)		 H05VW-F	PVC sheathed cable for low mechanical loads	All Cable Strippers (working range from 4 mm), No. 3, No. 200, No. 7 Magic	No. 2, No. 3, No. S 4-28 Multi, No. 5 Pro, No. 5, No. 6, No. 7 Magic, No. 7-F, No. 16, No. 100, No. 200, No. 400
		 H05RR-F	Rubber tube conductor for light mechanical loads	All Cable Strippers, No. 7 Magic, No. 13, No. 16, No. 100, No. 200, No. 400	No. S 4-28 Multi, No. 5 Pro, No. 5, No. 6, No. 7 Magic, No. 7-F, No. 16, No. 100, No. 200, No. 400
		 (N)FLGöu	Rubber control line	All Cable Strippers, No. 7 Magic, No. 13, No. 16, No. 100, No. 200, No. 400	No. S 4-28 Multi, No. 5 Pro, No. 5, No. 6, No. 7 Magic, No. 7-F, No. 16, No. 100, No. 200, No. 400
		 XYMM K3	PVC construction cable	All Cable Strippers, No. 7 Magic, No. 13, No. 16, No. 100, No. 200, No. 400	No. S 4-28 Multi, No. 5 Pro, No. 5, No. 6, No. 7 Magic, No. 7-F, No. 16, No. 100, No. 200, No. 400
		 ---	PVC control line	All Cable Strippers, No. 7 Magic, No. 13, No. 16, No. 100, No. 200, No. 400	No. S 4-28 Multi, No. 5 Pro, No. 5, No. 6, No. 7 Magic, No. 7-F, No. 16, No. 100, No. 200, No. 400
		 H05VV5-F	PVC control line oil resistant	All Cable Strippers, No. 7 Magic, No. 13, No. 16, No. 100, No. 200, No. 400	No. S 4-28 Multi, No. 5 Pro, No. 5, No. 6, No. 7 Magic, No. 7-F, No. 16, No. 100, No. 200, No. 400
		 H05VW-F	PVC hose line for medium mechanical stresses	All Cable Strippers, No. 7 Magic, No. 13, No. 16, No. 100, No. 200, No. 400	No. S 4-28 Multi, No. 5 Pro, No. 5, No. 6, No. 7 Magic, No. 7-F, No. 16, No. 100, No. 200, No. 400
		 H05V-K	PVC fine wire core conductor	---	No. S 4-28 Multi, No. 5 Pro, No. 5, No. 6, No. 7 Magic, No. 7-F, No. 16, No. 100, No. 200, No. 300, No. 400, Precision Wire Stripper S/ESD
		 H07V-K	PVC wiring conductor fine wire	---	No. S 4-28 Multi, No. 5 Pro, No. 5, No. 6, No. 7 Magic, No. 7-F, No. 16, No. 100, No. 200, No. 300, No. 400, Precision Wire Stripper S/ESD
		 LFZ-XY	Special PVC loud speaker cable	---	No. 7 Magic, No. 7-F

Category	Cable	Wire diameter Example type	Name	Suggested application Dismantling	Suggested application Stripping
Control and Electrical Lines (stranded conductors)		 (H)03VH-H	PVC twin conductor	---	No. 7 Magic, No. 7-F
		 H1Z2Z2-K	Solar cable	Mini-Solar No. 3, No. 7 Solar	Mini-Solar No. 3, No. 7 Solar
		 LiYY	Electronic control line	No. 2 Cat, No. 10, No. 30	No. 30, Precision Wire Stripper S/ESD
		 SIF	Silicone core conductor	---	No. 2, No. 3
		 H07RN-F	Heavy rubber hose line fine-stranded	No. 13 Classic	No. 5 Pro, No. 5, No. 16, No. 400, No.100
		 H07BQ-F	PUR connection and control cable fine-stranded	Cable Stripper No. 4-28 H, Cable Stripper No. 4-29 Spiral, No. 13 Classic	No. 5 Pro, No. 5, No. 16, No. 400
		 SIHF	Silicone connection and control line	No. 13, No. 13 Classic, No. 16, Cable Stripper No. 4-28 H	No. 5 Pro, No. 5, No. 16, No. 400
Data Cables Fibre Optic Cables Coaxial Cables		 RG 59 B/U	Coaxial cable for the transmission of high frequency signals	No. 1, No. 2, No. 3, No. 100	No. 1, No. 2, No. 3, No. 100
		 2YALGY	Coaxial cable (SAT compatible)	No. 1, No. 2, No. 3, No. 100	No. 1, No. 2, No. 3, No. 100
			BUS cable	No. 2 Cat, No. 10, No. 30	No. 30
			Profibus	Profibus Stripper No. 2	---
		 LAN 200flex	Patch cable with film shield for local networks	No. 2 Cat, No. 10, No. 30	No. 30
		 LAN 1000	Data cable (Cat 7)	No. 2 Cat, No. 10, No. 30	No. 30
		 A-DQ(ZN)B2Y	Fibre optic cable / Optical fibre	Cable Stripper No. 4-29 Spiral, Fibre Optic Tube No. 2 (of special buffer tubes for fibre optic cables)	Fibre Optic Stripper
Communication Lines		 YYSch	PVC insulated telecommunications sheathed wire 0.6 mm	No. 7 Magic	No. 5 Pro, No. 5, No. 6, No. 7 Magic, No. 7-F, Precision Wire Stripper S/ESD
		 YR	PVC insulated telecommunications sheathed wires 0.8 mm	No. 7 Magic	No. 5 Pro, No. 5, No. 6, No. 7 Magic, No. 7-F, Precision Wire Stripper S/ESD
		 F-vYAY	Installation cable for telecommunications systems	No. 2 Cat, No. 10, No. 30	No. 30, Precision Wire Stripper S/ESD
		 JE-Y(ST)Y Bd	Installation cable for industry electronics	No. 2 Cat, No. 10, No. 30	No. 30, Precision Wire Stripper S/ESD
Power Cables		 E-YY	PVC insulated high voltage cable, single and multi-core cable	No. 25, No. 1000	---
		 E-AYY	PVC insulated cable with aluminium conductor	No. 25, No. 1000	---

APPLICATION EXAMPLES



PHOTOVOLTAIC/SOLAR

Wire Stripper No. 7 Solar
Automatic stripping of solar cables



Mini-Solar No. 3
Stripping of solar cables



KITCHEN/LIVING ROOM

Round Cable Stripper No. 13
Stripping on cavity wall boxes



Wire Stripper No. 5
Stripping of all common stranded and solid wires



DIY/WORKSHOP

Duo-Crimp No. 300
Crimping wire end ferrules



Multi-Stripper No. 400
Wire stripping and dismantling



Precision Wire Stripper S
For thin wires and conductors



Also available as



Green Line®

More information on **page 6**



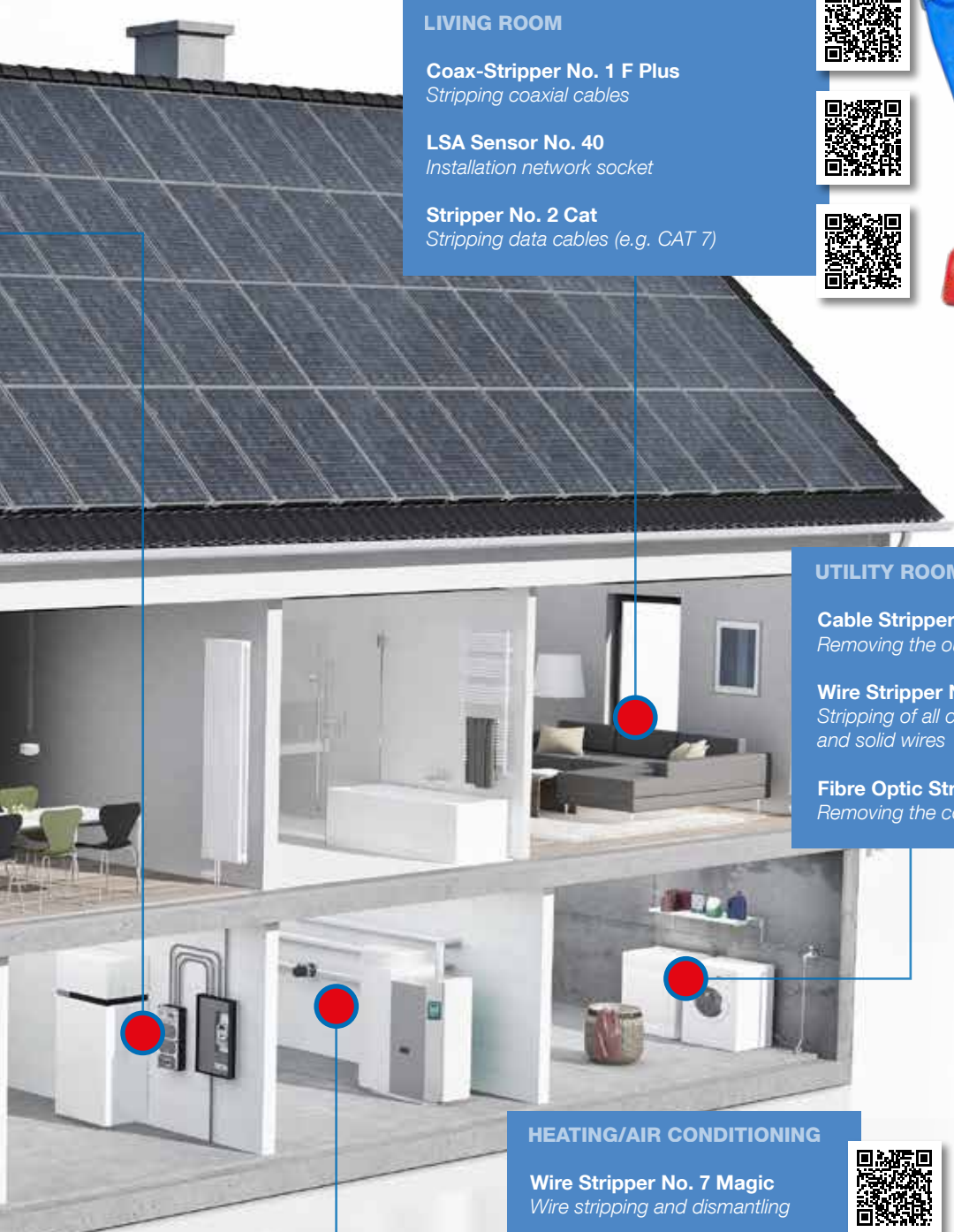

LIVING ROOM

Coax-Stripper No. 1 F Plus
Stripping coaxial cables

LSA Sensor No. 40
Installation network socket

Stripper No. 2 Cat
Stripping data cables (e.g. CAT 7)



UTILITY ROOM

Cable Stripper S 4-28
Removing the outer sheath, e.g. NYM

Wire Stripper No. 6
Stripping of all common stranded and solid wires

Fibre Optic Stripper
Removing the coating of fibre optic cables



HEATING/AIR CONDITIONING

Wire Stripper No. 7 Magic
Wire stripping and dismantling

Quadro-Stripper No. 16
Wire stripping and dismantling



SELLING AIDS

Equipment suggestion.
Supply of the displays is without products.

WEICON TOOLS
No. 1 in Form & Funktion

Green Line®



Display Green Line

50951051



Display Cable Stripper

50951050

2.330 mm

505 mm

460 mm



1.620 mm

480 mm

WEICON TOOLS Display

50952000

**WEICON TOOLS Display
with LED lighting**

50952000-LICHT



Roll-Up
99951078



Stickers



Poster

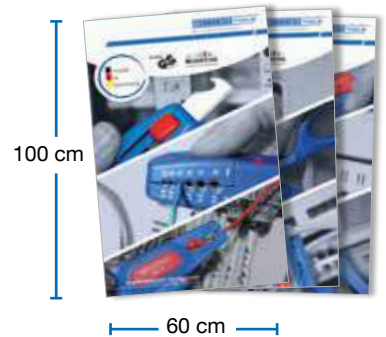

Foam Display without tools

50951199

Example: 12x Dismantler



Foam Display without tools

50951198

Example: 6x Wire Stripper

Green Line®

CABLE STRIPPERS

 Cable Stripper No. S 4-28 Art.-No. 50055328	 Cable Stripper No. S 4-28 Multi Art.-No. 50057328	 Cable Stripper No. 35-50 Art.-No. 50050450	 Cable Stripper No. 28-35 Art.-No. 50050435
 Cable Stripper No. 4-28 G Art.-No. 50054428	 Cable Stripper No. 4-28 H Art.-No. 50054328	 Cable Stripper No. 4-16 Art.-No. 50050116	 Cable Stripper No. 8-27 Art.-No. 50050227
 Cable Stripper No. C 4-16 Art.-No. 50053116	 Cable Stripper No. C 8-27 Art.-No. 50053227	 Cable Stripper No. C 4-28 Art.-No. 50053328	

CABLE STRIPPERS

 Cable Stripper No. S 4-28 Art.-No. 53055328	 Cable Stripper No. S 4-28 Multi Art.-No. 53057328
 Cable Stripper No. 4-28 H Art.-No. 53054128	 Cable Stripper No. 8-27 Art.-No. 53051227
 Cable Stripper No. 4-16 Art.-No. 53051116	

WIRE STRIPPERS

 Wire Stripper No. 5 Pro Art.-No. 51005005	 Wire Stripper No. 5 Art.-No. 51000005	 Wire Stripper No. 5 Classic Art.-No. 51003005	 Wire Stripper No. 6 Art.-No. 51000006
 Wire Stripper No. 7 Magic Art.-No. 51000007	 Wire Stripper No. 7-F Art.-No. 51001007	 Precision Wire Stripper S Art.-No. 51000002	 Fibre Optic Stripper Art.-No. 51002002
		 ESD Precision Wire Stripper Art.-No. 51001002	

WIRE STRIPPERS

 Wire Stripper No. 5 Art.-No. 54000005	 Precision Wire Stripper S Art.-No. 54000002
--	---

Sustainable Stripping Tools.
More informations on **page 6**.

STRIPPING TOOLS

 Coax-Stripper No. 2 Art.-No. 52000002	 Fibre Optic Tube No. 2 Art.-No. 52003002	 Profibus Stripper No. 2 Art.-No. 52004002	 Quadro-Stripper No. 16 Art.-No. 52000016
 Combi-Coax No. 3 Art.-No. 52000003	 Round Cable Stripper No. 13 Art.-No. 52000013	 Round Cable Stripper No. 13 Classic Art.-No. 52003013	 Stripper No. 2 Cat Art.-No. 52002002
 No. 1 F Plus for screw connectors Art.-No. 52000001	 No. 1 F Plus for compression connectors Art.-No. 52001001	 No. 1 F Plus for mini coaxial cables Art.-No. 52002001	 Cat Cable-Stripper No. 10 Art.-No. 52000010

STRIPPING TOOLS

 Coax-Stripper No. 1 F Plus Art.-No. 55000001	 Coax-Stripper No. 2 Art.-No. 55000002
 Quadro-Stripper No. 16 Art.-No. 55000016	 Round Cable Stripper No. 13 Art.-No. 55000013

Note: Work with WEICON TOOLS is only permitted on zero-potential cables and conductors.

Green Line®

MULTI-PURPOSE STRIPPERS



Duo-Crimp No. 300
Art.-No. 51000300

Mini-Duo No. 150
Art.-No. 51000150

Duo-Stripper No. 200
Art.-No. 51000200

Multi-Stripper No. 400
Art.-No. 51000400

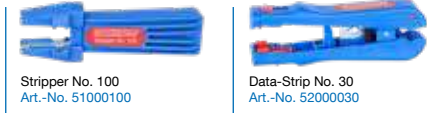

Stripper No. 100
Art.-No. 51000100

Data-Strip No. 30
Art.-No. 52000030

MULTI-PURPOSE STRIPPERS



Duo-Crimp No. 300
Art.-No. 54000300

Multi-Stripper No. 400
Art.-No. 54000400

Stripper No. 100
Art.-No. 54000100

Not just a **green** look!

SETS



Starter-Set Pro
Art.-No. 52880001

Crimping-Set Pro
Art.-No. 52880002

Electrical Installation Set 1
Art.-No. 52881001

Electrical Installation Set 2
Art.-No. 52881002

Electrical Installation Set 3
Art.-No. 52881003

Electrical Installation Set 4
Art.-No. 52881004

SETS



Starter-Set Pro
Art.-No. 55880001

SPECIAL TOOLS

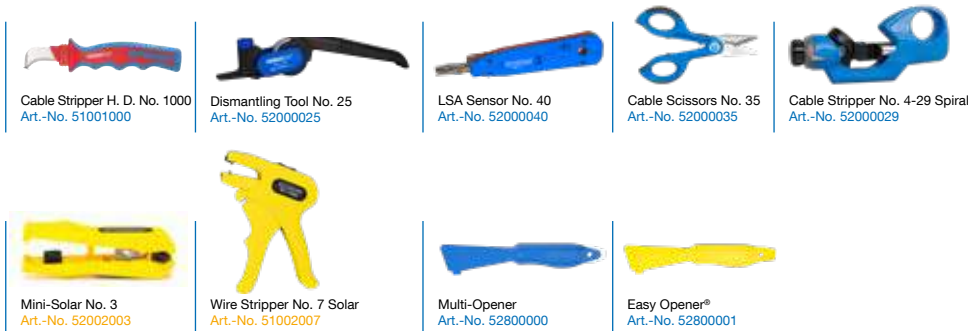

Cable Stripper H. D. No. 1000
Art.-No. 51001000

Dismantling Tool No. 25
Art.-No. 52000025

LSA Sensor No. 40
Art.-No. 52000040

Cable Scissors No. 35
Art.-No. 52000035

Cable Stripper No. 4-29 Spiral
Art.-No. 52000029

Mini-Solar No. 3
Art.-No. 52002003

Wire Stripper No. 7 Solar
Art.-No. 51002007

Multi-Opener
Art.-No. 52800000

Easy Opener®
Art.-No. 52800001

Note: Work with WEICON TOOLS is only permitted on zero-potential cables and conductors.

WEICON TOOLS®

No. 1 in Form & Funktion



Ultima Kft.
Központi raktár: 1172 Budapest, Rétifarkas utca 6.
Telefon: +36 1 432 8820
www.ultima.hu

